

**SONY**<sup>®</sup>

AIR/FM/LW/MW/SW PLL SYNTHESIZED RECEIVER  
FM/LW/MW/SW PLL SYNTHESIZED RECEIVER

# ICF-2001D

## OPERATING INSTRUCTIONS page 5

Before operating the set, please read this manual thoroughly.  
This manual should be retained for future reference.

## MODE D'EMPLOI page 22

Lire attentivement ce mode d'emploi avant la mise en service de  
l'appareil et le conserver pour toute référence ultérieure.

## MANUAL DE INSTRUCCIONES página 39

Antes de usar el aparato, lea este manual detenidamente.  
Consérvelo para futuras referencias.



**A**

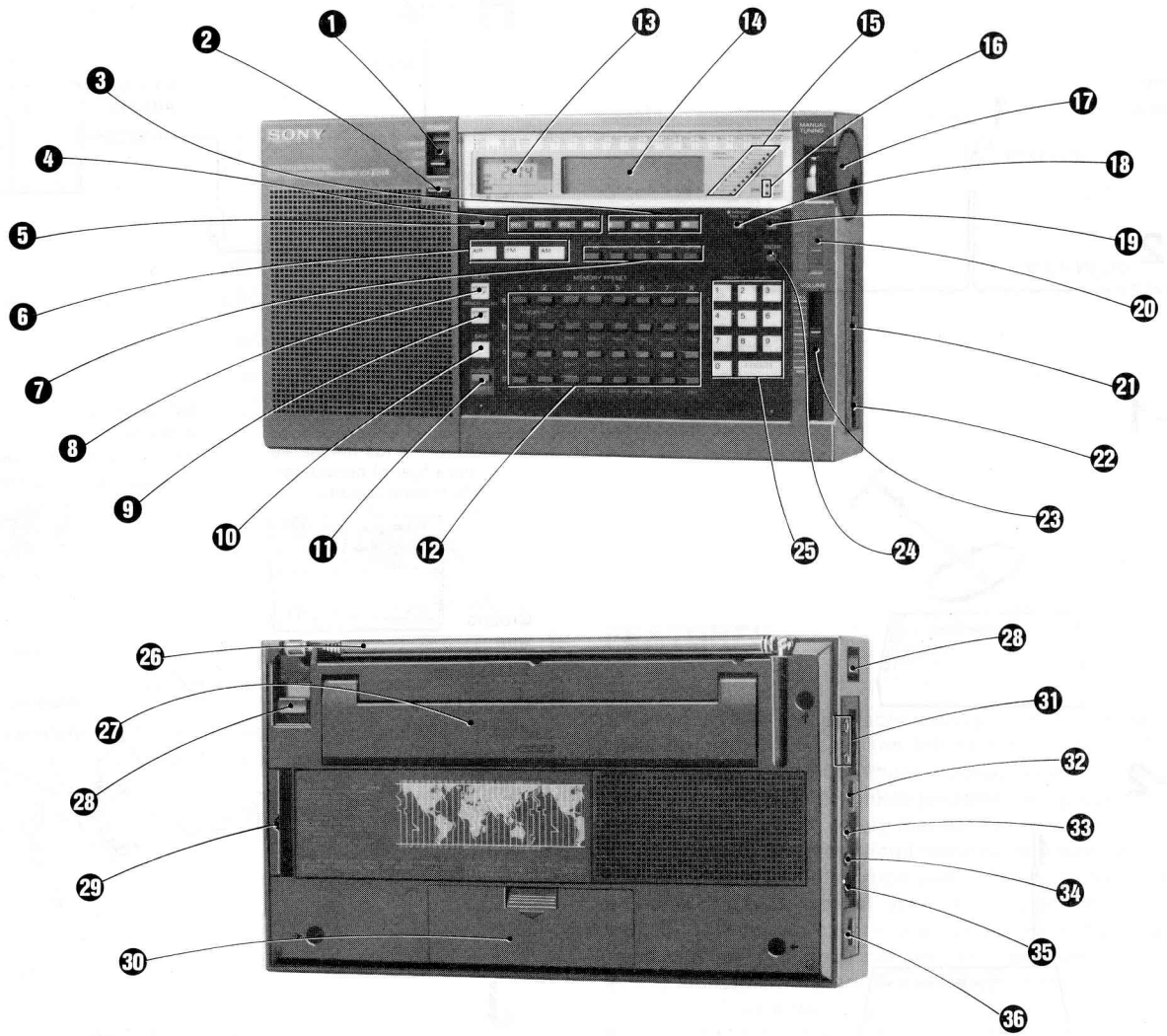

**B**

MEMORY PRESET

	1	2	3	4	5	6	7	8
a	SCAN	L2						
b	DEFINE	LW	MW	120m	90m	75m	60m	49m
c	41m	31m	25m	21m	19m	16m	13m	11m
d	FM	AIR	SCAN1	SCAN2	MW9kHz	MW0kHz	I2R	24H

Callouts 4, 5, and 6 point to the SCAN1, SCAN2, and MW9kHz/MW0kHz buttons respectively.

**D**

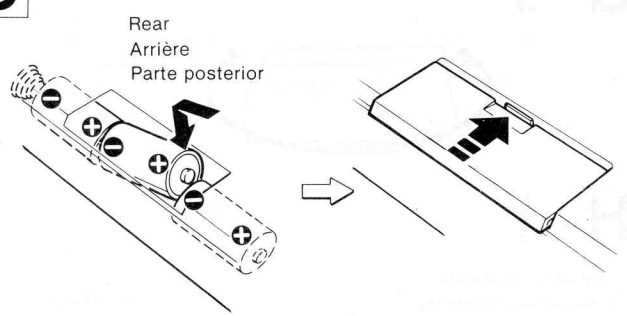

**C**

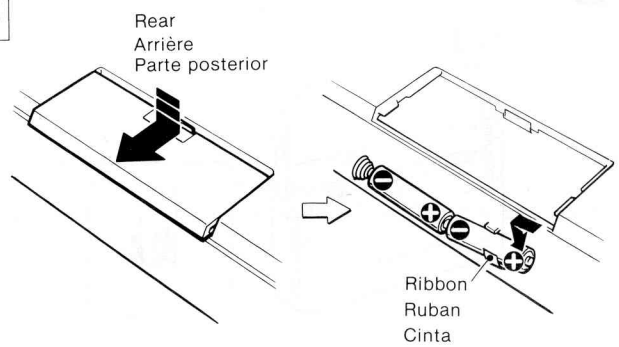

**E**

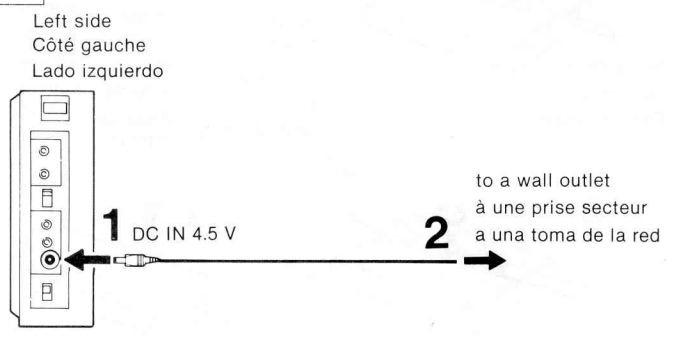

# F

Left side  
Côté gauche  
Lado izquierdo

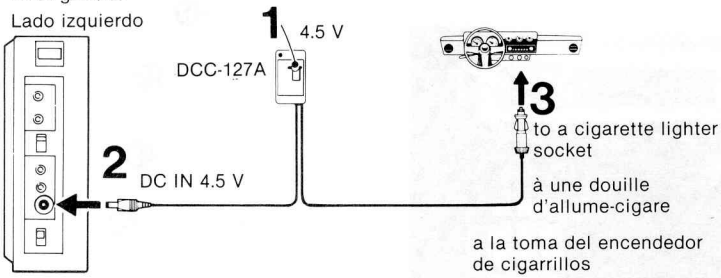

# G-1

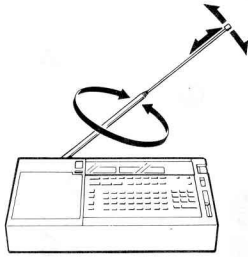

# G-2

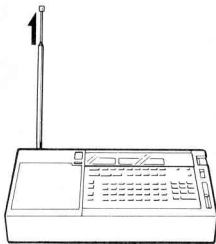

# G-3

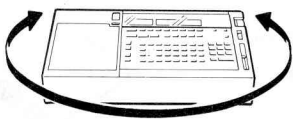

# H-1

1 Antenna connector  
Connecteur d'antenne  
Conector de antena

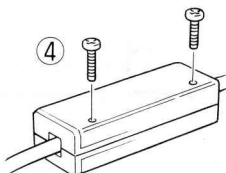
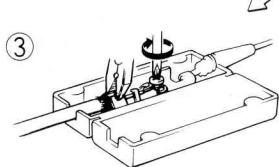
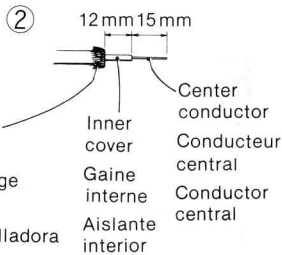
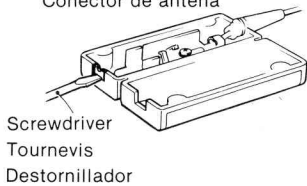

# H-2

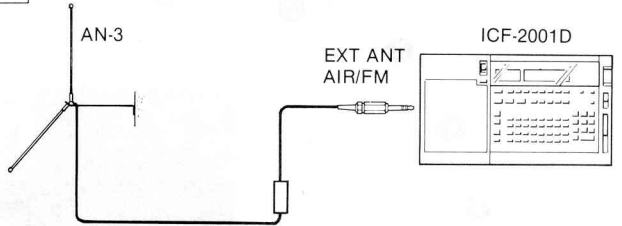

# I

Press the tabs to fix the ground wire  
Appuyer sur les onglets pour fixer le fil de terre  
Presione las lengüetas para fijar el conductor de puesta a tierra.

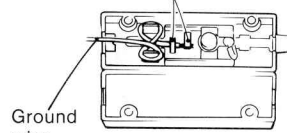

Ground wire  
Fil de terre  
Conductor de puesta a tierra

SW external antenna  
Antenne extérieure OC  
Antena exterior de SW

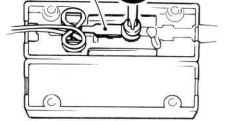

SW external antenna  
Antenne extérieure OC  
Antena exterior de SW

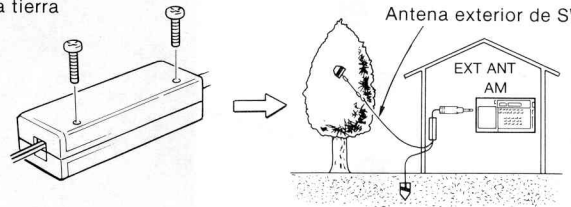

# J

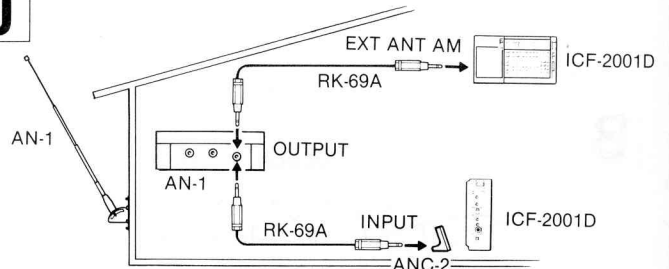

# K

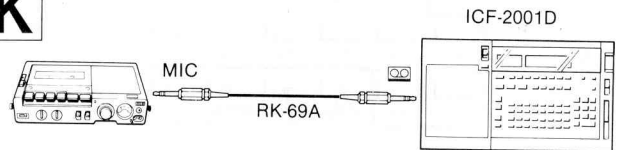

# L

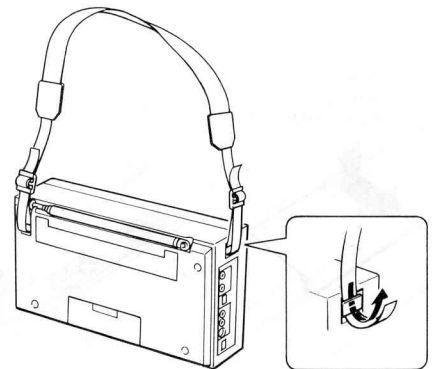

The ICF-2001D is available in various models with differences in tuning bands and frequencies, etc., corresponding to the regulations of different countries.

The main differences are as follows. Please check the type of your unit with respect to each item.

The AM and FM frequency ranges are indicated on the front panel of your unit. For other items, compare your unit with the photos on page 3 and the explanations of "LOCATION AND FUNCTION OF CONTROLS".

Item	Type	Description
AM frequency range	1	150 - 29,999.9 kHz
	2	150 - 26,100 kHz
	3	150 - 285 kHz and 530 - 26,100 kHz
FM frequency range	1	76 - 108 MHz
	2	87.5 - 108 MHz
AIR band (116 - 136 MHz)	1	Provided
	2	Not provided (No AIR key)
SSB reception	1	Provided
	2	Not provided (No USB and LSB/CW keys)
External antenna terminals	1	Provided
	2	Not provided

Despite the above differences, the operating procedure of all the units are identical. The differences are clearly described in the text as required.

The photos and illustrations used in this manual represent a typical model.

## WARNING

To prevent fire or shock hazard, do not expose the set to rain or moisture.

To avoid electrical shock, do not open the cabinet. Refer servicing to qualified personnel only.

### Notice for the customers in the United Kingdom IMPORTANT

The wires in the mains lead of the supplied ac power adaptor are coloured in accordance with the following code:

Blue: Neutral

Brown: Live

As the colours of the wires in the mains lead of this apparatus may not correspond with the coloured markings identifying the terminals in your plug proceed as follows:

The wire which is coloured blue must be connected to the terminal which is marked with the letter N or coloured black.

The wire which is coloured brown must be connected to the terminal which is marked with the letter L or coloured red.

The MW scanning interval is preset at the factory to 9 kHz. If you use the receiver where the frequency allocation system is based on a 10 kHz interval, such as in the U.S.A. and Canada, change the MW scanning interval following the procedure on page 15.

## TABLE OF CONTENTS

Features .....	5
Precautions.....	6
Location and function of controls .....	6
Computer/clock batteries .....	8
Radio power sources .....	9
Clock setting.....	10
Direct tuning .....	10
Manual tuning .....	11
For improved reception .....	12
Scan tuning .....	13
Memory tuning .....	15
Memory scan tuning .....	16
Sleep timer operation .....	17
Programmable timer operation .....	18
External antenna connection .....	19
Recording a broadcast .....	20
Specifications .....	20
Troubleshooting guide .....	21

## FEATURES

- An FM/LW/MW/SW portable receiver with worldwide band coverage. With certain models, the AIR band\* can be also received.
- Quartz controlled PLL (Phase Locked Loop) synthesizer system using a microcomputer makes pinpoint tuning easy.
- Smooth tuning with rotary manual tuning knob.
- Synchronous detector circuit reduces interference from adjacent stations (beats) and distortion due to fading in AM reception.
- Choice of direct, manual, scan, memory or memory scan tuning.
- Up to 32 stations can be memorized for instant tuning at the press of a key. AM mode can also be memorized.
- Programmable timer turns the receiver on and off automatically up to four times a day.
- Sleep timer turns the receiver off automatically after 60, 30 or 15 minutes.
- Three different radio power sources: internal batteries, house current or car battery.

### \* AIR band

The AIR band covers the air traffic control frequencies. You can monitor aviation communications between aircraft and airport towers, such as a pilot's request for instructions, a report of his position, and filing of his flight plans.

## PRECAUTIONS

- Operate the radio only on 4.5V dc with three IEC designation R20 batteries (size D).

For ac operation, use the ac power adaptor supplied for this set.\* For car battery operation, use the car battery cord recommended for this set.

- Operate the computer/clock only on 3V dc with two IEC designation R6 batteries (size AA).

- When the set is to be operated extensively on other power sources than batteries, remove the radio batteries.

- The set is not disconnected from the ac power source (mains) as long as it is connected to the wall outlet, even if the set itself has been turned off.

- Disconnect the ac power adaptor from the wall outlet when the set is not to be used for a long period of time.

- The nameplate indicating operating voltage, etc., is located on the back of the set.

- Use the set within a temperature range of 0°C to 40°C (32°F to 104°F). If it is used in temperatures outside this range, an irregular display may appear on the display windows. If it is used in temperatures lower than this range, the display may change very slowly. These irregularities will disappear and there will be no damage to the set when the set is used in its recommended temperature range.

- Do not leave the set near heat sources, such as radiators or air-ducts, or in a place subject to direct sunlight, excessive dust, moisture, rain, mechanical vibration, or shock.

- Should any solid object or liquid fall into the set, remove the batteries, and have the set checked by qualified personnel before operating it any further.

- Since a strong magnet is used for the speaker, metallic objects such as pins, etc., may cling to the set. Keep personal credit cards using magnetic coding, recorded tapes, and spring-wound watches away from the set to prevent damage by the magnet.

- When the case becomes soiled, clean it with a soft cloth dampened with a mild detergent solution. Never use abrasive cleansers or chemical solvents, as they may mar the case.

- In vehicles or in buildings, radio reception may be difficult or noisy. Try listening near a window.

- When there is lightning and you are using an external antenna, immediately disconnect the ac power adaptor (if connected) from the wall outlet. Never touch the antenna wire when there is lightning storm.

- Never connect a ground wire to a gas pipe.

- Reception of 455 kHz, 3640 kHz and 6275 kHz may be difficult because of internal spurious signals generated by the built-in oscillators.

If you have any question or problem concerning your set that is not covered in this manual, please consult your nearest Sony dealer.

\* The ac power adaptor is **not** supplied with the model available in Australia. For an optional ac power adaptor, contact your nearest Sony dealer.

## LOCATION AND FUNCTION OF CONTROLS

See photos **A** on page 3.

### ❶ POWER switch

After setting the MAIN POWER switch **❶** to ON, set to ON to turn on the receiver. To turn the receiver off, set to OFF. To activate the programmable timer, set to TIMER.

### ❷ LIGHT key

Press to illuminate the display windows for approximately 15 seconds. If any key on the front panel is pressed or the MANUAL TUNING/TIME ADJ knob **❷** is turned, the illumination will remain for another 15 seconds from that point. The illumination will go off automatically 15 seconds after the last key is pressed.

### ❸ OPERATION TIME keys (page 18)

To set the operation time of the programmable timer, keeping a PROGRAMMABLE TIMER key **❸** pressed, press the 0, 15, 30 or 60 (minute) key.

### ❹ PROGRAMMABLE TIMER keys (page 18)

Keeping one of these keys pressed, set the turn-on time, the operation time, and the station to be turned on (the MEMORY PRESET key) by the programmable timer. Four different timer programs can be set on the four PROGRAMMABLE TIMER keys.

### ❺ SLEEP timer key (page 17)

Press to set the operation time of the sleep timer.

Press this key repeatedly until the desired time, 60, 30 or 15 (minutes), is displayed.

### ❻ Band select keys

Select the desired band.

**AIR:** For air band reception (not provided with certain models).

**FM:** For FM reception.

**AM:** For LW, MW and SW reception.

### ❼ AM mode select keys (page 12)

Select the appropriate AM mode according to the type of broadcasting and receiving conditions.

(With certain models, USB and LSB/CW keys are not provided.)

### ❽ SCAN START/STOP key (page 13)

Press to start and stop scanning.

### ❾ MEMORY SCAN START/STOP key (page 16)

Press to start and stop memory scanning.

### ❿ SKIP key (page 16)

Used to designate the memorized stations to be skipped during memory scanning.

### ⓫ SHIFT key

To activate the second function of the MEMORY PRESET keys (indicated below the keys in blue), keeping this key pressed, press the required MEMORY PRESET key. (See "Second function of the MEMORY PRESET keys" on page 8.)

### ⓬ MEMORY PRESET keys

One station (its frequency and AM mode) can be memorized with each MEMORY PRESET key. To memorize a station, keeping the ENTER key **⓬** pressed, press a MEMORY PRESET key.

Most of the MEMORY PRESET keys are dual function. To activate the second function, keeping the SHIFT key **⓫** pressed, press the MEMORY PRESET key. See "Second function of the MEMORY PRESET keys" on page 8.

### 13 Clock/timer display

Normally the present time is displayed. When the PROGRAMMABLE TIMER key 1 is pressed, the timer program is displayed. When the sleep timer is operating, the operation time of the sleep timer is displayed.

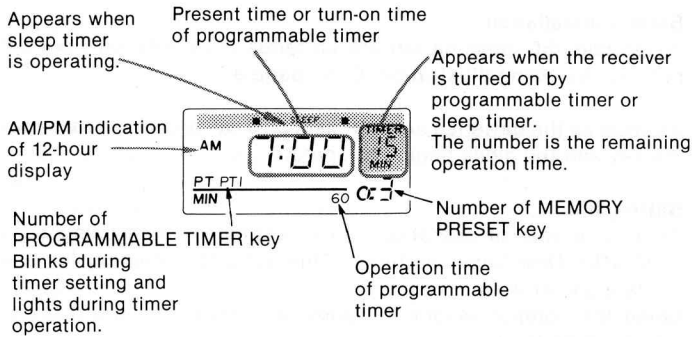

### 14 Frequency display

Displayed as follows.

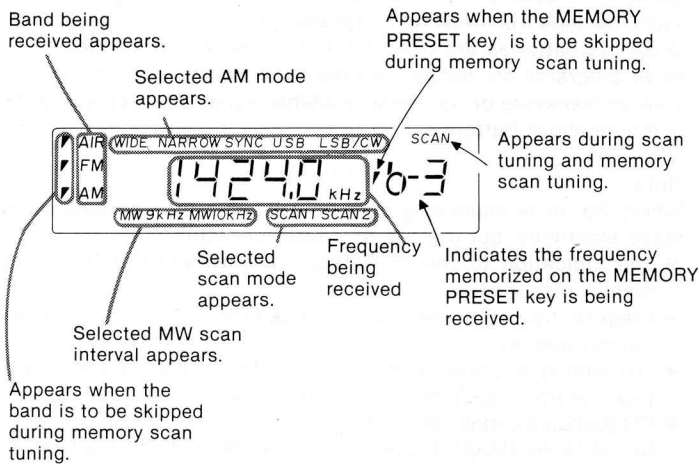

### 15 SIGNAL STRENGTH/BATTERY indicator

Shows the strength of the tuned signal. The more LEDs illuminated, the better the tuning. While the BATTERY CHECK key 16 is pressed, this indicator shows the battery condition.

### 16 SYNC (synchronous detection) indicators (page 13)

When a signal is received with AM mode set to SYNC, one of the SYNC indicators lights to show the sideband selected by the synchronous detector circuit.

Fine tune to the best possible reception with the MANUAL TUNING knob 17, monitoring the SYNC indicators.

### 17 MANUAL TUNING/TIME ADJ knob

For manual tuning, turn this knob to tune in a frequency. To set the clock, keeping the PRESENT TIME SET key 18 pressed, turn this knob. To set the turn-on time of the programmable timer, keeping the PROGRAMMABLE TIMER key 1 pressed, turn this knob.

### 18 PRESENT TIME SET key

To set the clock, keeping this key pressed, turn the MANUAL TUNING/TIME ADJ knob 17.

### 19 BATTERY CHECK key

To check the battery condition, keeping this key pressed, monitor the SIGNAL STRENGTH/BATTERY indicator 15.

### 20 MANUAL TUNE MODE selector (page 12)

When this selector is set to FAST, AM frequency is changed by 1 kHz intervals by turning the MANUAL TUNING/TIME ADJ knob 17. When the selector is set to SLOW, AM frequency is changed by 0.1 kHz intervals. When the selector is set to LOCK, the frequency of all the bands will not change even if the MANUAL TUNING/TIME ADJ knob is turned. (Clock and timer settings can be made.)

### 21 AM RF GAIN control

Normally set to MAX. When the sound of an AM station is distorted due to strong signals, slide it towards MIN. During scan tuning, adjust the stop level of scanning with this control.

### 22 TONE selector

Set to the appropriate position according to the program or to your preference.

HIGH: For more treble.

LOW: For less treble.

NEWS: For listening to news.

### 23 VOLUME control

Slide towards MAX for more volume.

### 24 ENTER key

Used to memorize a station. After tuning in a frequency and selecting AM mode, keeping this key pressed, press a MEMORY PRESET key.

### 25 DIRECT TUNING keys

For direct tuning, input a frequency with the keys 0-9 and then press the EXECUTE key.

### 26 Telescopic antenna (page 12)

Used for FM, SW and AIR band reception.

### 27 Stand

Press the part marked **PUSH UP** to raise the stand. To lower it, press the same part again.

### 28 Loops for shoulder strap

### 29 Information plate

Pull out the plate to the left to remove, stick the supplied memo sheet on the front side and the supplied information sheet on the rear and replace the plate.

When referring to the information, slide it out as required.

### 30 Battery compartment (page 8)

Install the computer/clock batteries and radio batteries.

### 31 EXT ANT (external antenna) jacks (page 19)

(Not provided with certain models)

Connect the supplied SW external antenna or an optional external AM antenna to the EXT ANT AM jack. Connect an optional external antenna for FM and AIR reception to the EXT ANT FM/AIR jack.

### 32 AM ATT (AM attenuator) selector

Used for AM reception. Normally set to DX. When receiving a strong signal, or at night when it is difficult to pick up a weak signal because of interference from many other signals, set to LOCAL.

### 33 (recording output) jack (page 20)

Used to record broadcast programs with a tape recorder.



## COMPUTER/CLOCK BATTERIES

### ④ Earphone jack ② (minijack)

Connect any earphone or headphones. When either of them is inserted in this jack, the built-in speaker will be disconnected automatically. The sound will be monaural even if you use stereo headphones.

### ⑤ DC IN 4.5V (external power input) jack

Connect an ac power adaptor or car battery cord.

### ⑥ MAIN POWER switch

Set to ON to turn on the receiver.

When carrying the receiver, set it to OFF to prevent the receiver from turning on accidentally. When this switch is set to OFF, only the clock operates.

## SECOND FUNCTION OF THE MEMORY PRESET KEYS

Most of the MEMORY PRESET keys are dual function. The first function is frequency memorization, and the second is indicated in blue below the key.

To use the second function, keeping the SHIFT key pressed, press the MEMORY PRESET key.

See illustration [B] on page 3.

### ① L1/L2 SCAN (scan range check) keys

Keeping the SHIFT key pressed, press the L1 key or the L2 key, and the lowest frequency or the highest frequency of the preset scan range appears on the frequency display.

### ② DEFINE scan key (page 13)

To scan between the frequencies memorized on the a-1 key and the a-2 key, keeping the SHIFT key pressed, press this key.

### ③ Band scan keys

To select the factory-preset scan range, which is a conventional broadcast band, keeping the SHIFT key pressed, press the corresponding key. The frequency range of each broadcast band is indicated on page 14.

### ④ Scan mode select keys

Keep the SHIFT key pressed and press the SCAN 1 key. Scanning will stop automatically when a signal is received.

Keep the SHIFT key pressed and press the SCAN 2 key. Scanning will stop for 1.5 seconds when a signal is received, and will then resume automatically.

### ⑤ MW scan interval select keys (page 15)

Set the MW scan interval to 9 kHz or 10 kHz according to the MW frequency allocation system of your country.

### ⑥ Hour display format select keys (page 10)

Select either 12 hour display or 24 hour display.

The MEMORY PRESET key is illustrated and described as follows in the text of this manual.

Ex. ② DEFINE scan key

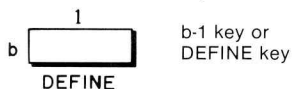

b-1 key or  
DEFINE key

These batteries are used to operate the clock, displays, and microcomputer which controls the receiver and retains the memory. Be sure to keep the batteries installed even when the receiver is operating on other power sources than the radio batteries.

### Battery installation

Insert two IEC designation R6 batteries (size AA) with correct polarity, following illustration [C] on page 3.

As soon as the batteries are installed, 0:00 will appear on the clock display and the clock begins to operate.

### Battery life

About one year of operation can be expected when using Sony SUM-3(NS) New Super batteries. This assumes listening for four hours a day at normal volume.

When the computer/clock batteries are exhausted, the displays may become faint.

### Replacement of the batteries

Be sure to replace both computer/clock batteries once a year to avoid damage from leaking batteries.

Once the batteries are removed, the memorized frequencies and timer programs are erased and the clock setting is cancelled. Be sure to memorize or set these contents again after replacing the computer/clock batteries.

### Note

When the air is especially dry, the following may be caused by static electricity, but there is no cause for alarm:

- The indication in the clock/timer display and the frequency display disappears.
- Irregular figures appear in the clock/timer display and the frequency display.
- The indication preset at the factory—0:00 or AM 150.0 kHz—appears in the clock/timer or frequency display.
- Frequencies cannot be tuned in.

If any of these things happens, set the MAIN POWER switch to OFF, and reset to ON. If the problem persists, remove and re-install the computer/clock batteries.

## RADIO POWER SOURCES

For receiver operation, the computer/clock batteries and one of the following three radio power sources are necessary.

### RADIO BATTERIES

#### Battery installation

Insert three IEC designation R20 batteries (size D) with correct polarity, following illustration [D] on page 3.

- The set cannot be operated on the internal batteries when the ac power adaptor or car battery cord is connected to the set.
- When the set is not to be used for a long period of time or is to be operated extensively on other power sources, remove the batteries to avoid damage caused by battery leakage and corrosion.

#### Battery life

You can expect Sony SUM-1(NS) New Super batteries to last for approx. 32 hours for AM/AIR reception and approx. 45 hours for FM reception. This assumes listening for four hours a day at normal volume.

#### To check the battery condition

- 1 Set the MAIN POWER switch and the POWER switch to ON.
- 2 Keeping the BATTERY CHECK key pressed, monitor the SIGNAL STRENGTH/BATTERY indicator. If the LEDs do not light up to the green zone, replace all batteries with new ones.

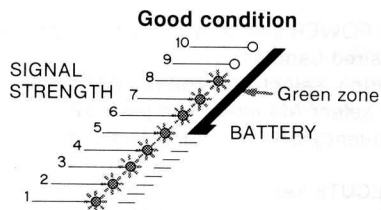

- When the batteries are exhausted, the sound becomes weak or distorted.

#### HOUSE CURRENT (except the model available in Australia)

Use the supplied ac power adaptor. The adaptor operates on either 110 (99–121)\*, 120 (108–132), 220 (198–242) or 240 V (216–264 V) ac, 50/60 Hz.

\* Range of voltage allowable shown in parentheses.

- 1 Before connecting the adaptor to a wall outlet, be sure to check whether the input selector is correctly set to your local power line voltage. If necessary, turn the selector with a screwdriver so that you can see the proper voltage figure.

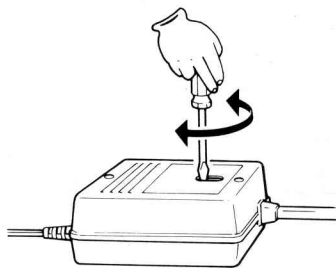

- 2 Connect the adaptor as in illustration [E] on page 3.

#### 12 V CAR BATTERY

Connect the Sony DCC-127A car battery cord (optional) as in illustration [F] on page 4.

- Before connecting, be sure to read the instruction manual for the car battery cord.

- Reception may be affected by ignition noise while the engine is in operation.

#### Notes

- When the ac power adaptor or car battery cord is connected to the DC IN 4.5 V jack, the internal radio batteries (if present) are automatically disconnected.

- If a car battery cord or an ac power adaptor not manufactured by Sony is used, a fuse must be installed in the battery cord or the ac power adaptor and the polarity of the plug must be as illustrated.

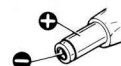



## CLOCK SETTING

When the computer/clock batteries are installed, the clock begins to operate from 0:00.

### To set the clock

- 1 Keeping the PRESENT TIME SET key pressed, turn the MANUAL TUNING/TIME ADJ knob so the display shows present time.
- 2 As soon as you hear the time signal on the telephone, radio or TV, release the PRESENT TIME SET key.  
The clock will then begin to operate, showing the precise time of day.

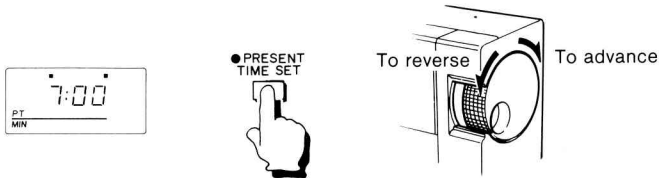

### To change the hour display format

The hour display format of the clock is preset at the factory to 24-hour display. You can change to a 12-hour display as follows:

- 1 Set the MAIN POWER switch and the POWER switch to ON.
- 2 Keeping the SHIFT key pressed, press the 12H key.

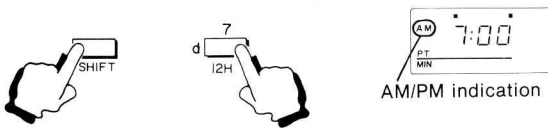

Check the AM/PM indication.

AM 12:00 = midnight PM 12:00 = noon

- To reset to the 24-hour display, keeping the SHIFT key pressed, press the 24H key.
- Once the computer/clock batteries are removed, the 24-hour display is automatically selected.

## DIRECT TUNING

If you know the frequency of a station to be received, you can tune in the station easily by direct tuning.

The numbers in the illustration refer to the sequence of operations.

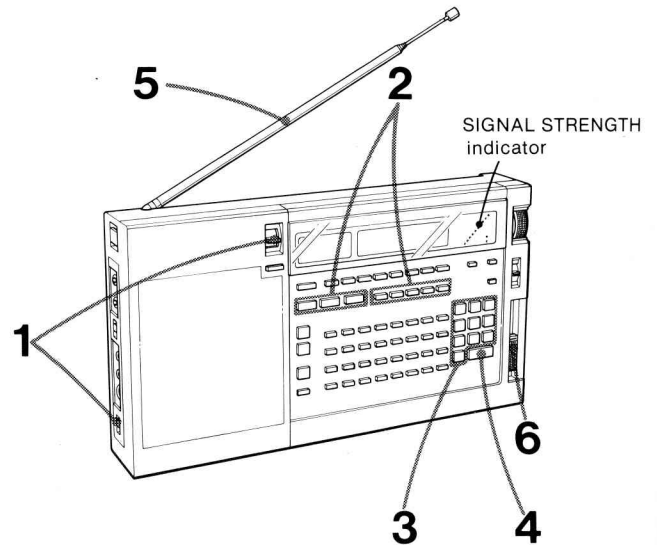

- 1 Set the MAIN POWER switch and the POWER switch to ON.
- 2 Select the desired band.  
For AM reception, select the required AM mode. (See "How to select AM mode" on page 12.)
- 3 Input the frequency of the station to be received with the 0-9 keys.
- 4 Press the EXECUTE key.
- 5 Adjust the telescopic antenna for FM/SW/AIR reception.  
Rotate the set for improved LW/MW reception. See page 12.
- 6 Adjust the volume with the VOLUME control.

After listening, set the POWER switch to OFF.

### HOW TO INPUT A FREQUENCY

#### Example

AM 1,242 kHz



FM 92.5 MHz



## MANUAL TUNING

### To input a frequency whose righthand digits are all 0

AM 2,000 kHz



FM 90.0 MHz



In case of 10,000 kHz and 20,000 kHz, however, press **1 0** **EXECUTE**, and **2 0** **EXECUTE**, respectively.

In case of 200 kHz, 300 kHz, ... 900 kHz, press **2 0 0** **EXECUTE**; **3 0 0** **EXECUTE**, etc.

- After pressing a key, press the next key within 5 seconds. If you do not, the previous station will return.

- With direct tuning, the frequency is displayed in steps of the following intervals, depending on the bands.

AM: 1 kHz

FM: 0.05 MHz

AIR: 0.025 MHz

If you input a frequency between the intervals, the frequency at the interval just below will be tuned in and displayed. For example, if you input FM 92.540 MHz, FM 92.500 MHz will be tuned in and displayed.

### Error indication

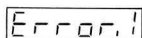

When you input a frequency beyond the receivable frequency range, this indication will blink several times and the previous station will return. ➔ Input a correct frequency.

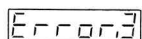

If you set the POWER switch to ON or press the SLEEP key when there is no radio power source, this indication will appear for approx. 5 seconds and then disappear.

➔ Check the following.

- The MAIN POWER switch is set to OFF.
- The radio batteries are exhausted.
- The ac power adaptor or the car battery cord is connected to the DC IN 4.5 V jack when battery operation is attempted.
- The ac power adaptor or the car battery cord is not connected correctly to a wall outlet or a cigarette lighter socket of a car.

Use manual tuning when you do not know the frequency of the station you want to tune in, or when you want to tune in a station more precisely after scan tuning.

The numbers in the illustration refer to the sequence of operations.

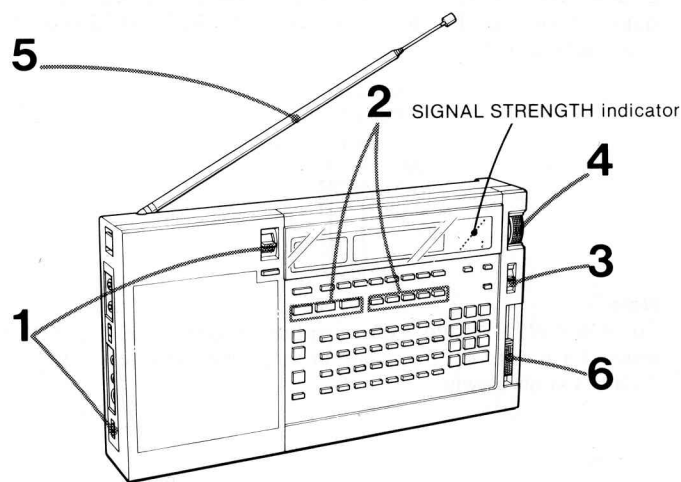

- 1 Set the MAIN POWER switch and the POWER switch to ON.
- 2 Select the desired band.  
For AM reception, select the required AM mode.  
(See "How to select AM mode" on page 12.)
- 3 Set the MANUAL TUNE MODE selector to SLOW or FAST.
- 4 Turn the MANUAL TUNING knob to tune in a desired station so that more LEDs of the SIGNAL STRENGTH indicator light.

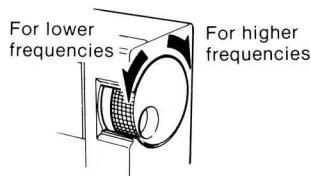

As the MANUAL TUNING knob is turned, the frequency is tuned in and displayed at the following intervals, depending on the bands.

AM: 0.1 kHz (with the MANUAL TUNE MODE selector set to SLOW)  
1 kHz (with the MANUAL TUNE MODE selector set to FAST)

FM: 0.05 MHz

AIR: 0.025 MHz

- 5 Adjust the antenna. See page 12.
- 6 Adjust the volume with the VOLUME control.

After listening, set the POWER switch to OFF.

### Note

When the upper or lower limit of the band frequency is reached, the frequency no longer changes even if the MANUAL TUNING knob is turned further.

## FOR IMPROVED RECEPTION

### How to use the MANUAL TUNE MODE selector

The manual tuning interval of AM frequency can be set with the MANUAL TUNE MODE selector, to 0.1 kHz (at SLOW position) or 1 kHz (at FAST position).

After tuning in a station with the selector set to FAST, tune it in more precisely, setting the selector to SLOW. Once the frequency of any band is precisely tuned, set the selector to LOCK. The frequency no longer changes even if the MANUAL TUNING knob is accidentally turned.

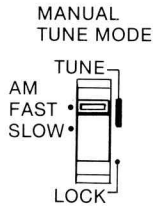

### Note

For AM (LW, MW and SW) reception in SYNC, USB or LSB/CW mode, be sure to set this selector to SLOW and turn the MANUAL TUNING knob slowly.

### ANTENNA ADJUSTMENT

#### For FM/AIR reception

Pull out the telescopic antenna to expose its swivel base and adjust its length, angle and direction for optimum reception. For AIR reception, extending two sections of the antenna is recommended. See illustration [G]-1 on page 4.

#### For SW reception

Pull out the telescopic antenna to its full length and set it vertically. See illustration [G]-2 on page 4.

- If there is a fluorescent lamp just above the set and reception is noisy, incline and shorten the telescopic antenna.

#### For MW/LW reception

Retract the telescopic antenna. The built-in ferrite bar antenna activates. Since this antenna is directional, rotate the set horizontally for optimum reception, if necessary. See illustration [G]-3 on page 4.

### Notes

- If reception is unsatisfactory with the telescopic antenna or the built-in ferrite bar antenna, connect an external antenna\*. To connect an external antenna, see page 19.
- In vehicles or in buildings, radio reception may be difficult or noisy. Try listening near a window.
- If the received sound is distorted or noisy, adjust the antenna carefully. For AM reception, set the AM ATT selector to LOCAL.

\* With certain models, the external antenna jacks are not provided.

### HOW TO SELECT AM MODE

Select the appropriate AM mode according to the broadcast or receiving conditions.

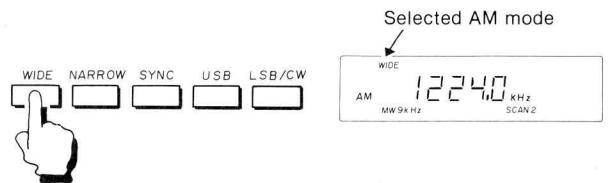

**WIDE:** Normally set to this mode for wider selectivity.

**NARROW:** If reception is interrupted or noisy, set to this mode for narrower selectivity. Reception will be improved.

**SYNC:** If reception is difficult because of beats from adjacent stations or distortion due to fading, which frequently occurs during AM (LW, MW and SW) reception, set to this mode and proceed as in "Tuning using synchronous detection".

**USB:** For USB (upper sideband) reception.\*

**LSB/CW:** For LSB (lower sideband) or CW (International Morse Code) reception.\*

\* With certain models, USB and LSB/CW receptions are not available so these keys are not provided.

## SCAN TUNING

### TUNING USING SYNCHRONOUS DETECTION

- 1 Tune in the desired station.
- 2 Press the SYNC key. The SYNC indication will be displayed and the UPPER or LOWER SYNC indicator will light up.
- 3 Set the MANUAL TUNE MODE selector to SLOW.
- 4 Turn the MANUAL TUNING knob slowly so that the other SYNC indicator lights. Choose the best possible tuning point, monitoring the received sound.

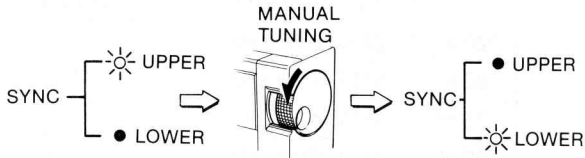

While tuning, a beat (whistling noise) may be heard when the extremely weak signal is received. If this happens, repeat the steps 3 and 4.

**To cancel the SYNC mode**, press the SYNC key again. The SYNC indication will disappear.

#### What is synchronous detection?

There are two big problems in AM reception: distortion due to fading and interference from adjacent stations. The synchronous detection is effective to these problems.

Distortion due to fading is caused by overmodulation, which occurs when a carrier component of the received signal is attenuated on the way. In this receiver, a pure carrier frequency with no level variation, perfectly synchronized with the original carrier, is generated in the synchronous detector circuit and is mixed with the received signal to compensate the attenuated carrier component. In this way, distortion is remarkably reduced.

On the other hand, AM (LW, MW and SW) broadcasting generally uses double-sideband transmission, in which modulated signals are transmitted using both the upper and lower sidebands (USB and LSB). In most cases one of the sidebands is affected by interference from adjacent stations (beats). In the synchronous detector circuit, one of USB and LSB can be received. This allows clear reception without interference from adjacent stations.

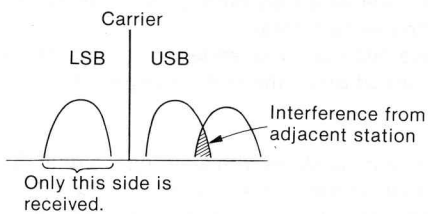

Use scan tuning to automatically scan the stations in the frequency range of a broadcast band or the range which you want. Two scan modes are selectable:

SCAN 1 mode to stop scanning at the first station located, or SCAN 2 mode to stop scanning for 1.5 seconds at each station located.

The numbers in the illustration refer to the sequence of operations.

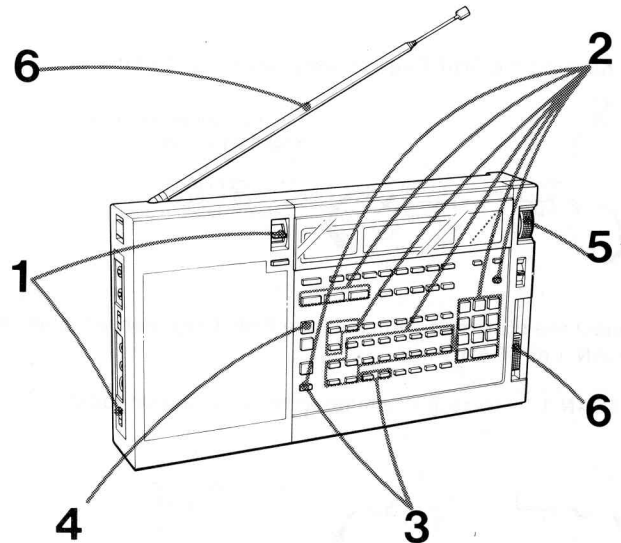

- 1 Set the MAIN POWER switch and the POWER switch to ON.
- 2 Select the broadcast band scan or the DEFINE scan.

#### Broadcast band scan

—To scan one of the broadcast bands preset in this receiver (For the frequency range of each band, see the list on page 14.)

**Keeping the SHIFT key pressed**, press the MEMORY PRESET key with the required band indication, LW through AIR (or LW through FM for certain models).

Example: SW 31 m band (9,400–10,000 kHz)

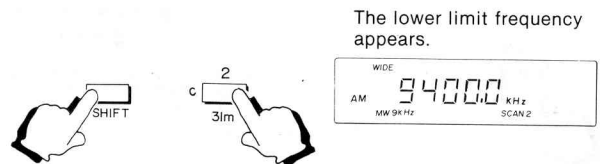

#### DEFINE scan

—To scan between the desired frequencies, in a part of a broadcast band or beyond a broadcast band

- ① Memorize the lower limit frequency and the upper limit frequency to the a-1 and a-2 keys as follows: Tune in the frequency with direct tuning, and keeping the ENTER key pressed, press the a-1 or a-2 key.

Example: FM 90 MHz - 100 MHz

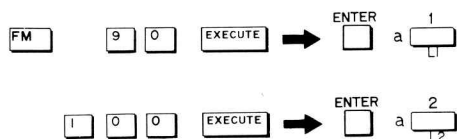

2 Keeping the SHIFT key pressed, press the DEFINE key.

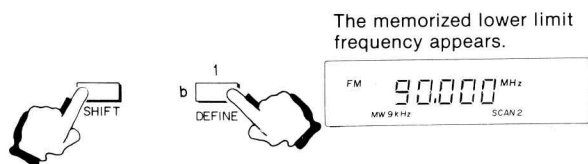

3 Select the scan mode. Keeping the SHIFT key pressed, press the SCAN 1 or SCAN 2 key.

**SCAN 1** —To stop scanning at the first station located



**SCAN 2** —To stop scanning for 1.5 seconds at each station located

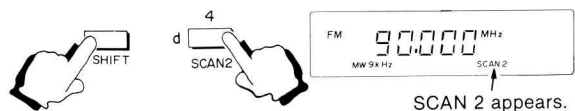

\* SCAN 2 mode is factory-preset.

4 Press the SCAN START/STOP key to start scanning.

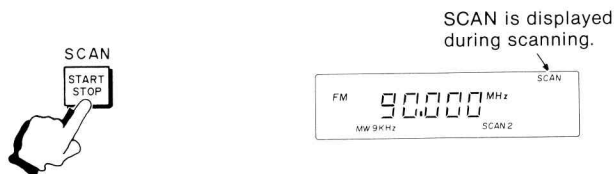

- To resume scanning in SCAN 1 mode, press the SCAN START/STOP key again. Repeat this procedure until the desired station is located.
- In SCAN 2 mode, press the SCAN START/STOP key when the desired station is located. The station is tuned in continuously.
- When the upper limit frequency is reached, the receiver will scan back to the lower limit with a beep.

5 If necessary, tune in the station precisely with the MANUAL TUNING knob.

6 Adjust the antenna and the volume.

After listening, set the POWER switch to OFF.

## BROADCAST BANDS

You can designate a broadcast band to be scanned from the following, by pressing the SHIFT key and the corresponding MEMORY PRESET key.

Broadcast band	Frequency range to be scanned	Scanning interval
LW	150 - 285 kHz	3 kHz
MW	531 - 1620 kHz (530 - 1620 kHz)	9 kHz (10 kHz)
SW	120 m	2250 - 2550 kHz
	90 m	3150 - 3450 kHz
	75 m	3850 - 4050 kHz
	60 m	4700 - 5110 kHz
	49 m	5900 - 6250 kHz
	41 m	7000 - 7400 kHz
	31 m	9400 - 10000 kHz
	25 m	11500 - 12150 kHz
	21 m	13500 - 13900 kHz
	19 m	15000 - 15700 kHz
FM	Type 1	76.0 - 108.0 MHz
	Type 2	87.5 - 108.0 MHz
	0.05 MHz	
	0.025 MHz	
AIR *	116 - 136 MHz	0.025 MHz

\* Not provided with certain models.

- The frequency ranges of the SW meter bands to be scanned are somewhat wider than those indicated on the front panel of the receiver.
- The frequencies between two SW meter bands can be scanned with the DEFINE scan at a 5 kHz scanning interval.

### To check the frequency range to be scanned

Keeping the SHIFT key pressed, press the L1 (a-1) key or the L2 (a-2) key. The lower limit frequency or the upper limit frequency appears on the frequency display.

- The selected scanning range is memorized even after the receiver is once turned off or the station beyond the range is tuned in.

### Notes

- Since scanning stops with a stronger signal than the preset level, it may stop a little before or after the exact frequency of a station. If this happens, tune in the station precisely with the MANUAL TUNING knob.
- When scanning does not stop at all during AM (LW, MW or SW) reception, make sure the AM RF GAIN control (right side) is set to MAX and the AM ATT selector (left side) is set to DX.
- When scanning stops at a noise or many unwanted stations during AM reception, slide the AM RF GAIN control slightly toward MIN. Then, set the AM ATT selector to LOCAL.
- AM mode, scanning range setting, scan mode and MW scanning interval cannot be changed during scanning.

## MEMORY TUNING

### HOW TO CHANGE THE MW SCANNING INTERVAL

The MW scanning interval is preset at the factory to 9 kHz to match the frequency allocation system of most countries.

If you use the receiver where the frequency allocation system is based on a 10 kHz interval, such as in the U.S.A. and Canada, change the MW scanning interval as follows:

- 1 Set the MAIN POWER switch and the POWER switch to ON.
- 2 Keeping the SHIFT key pressed, press the MW 10 kHz key.  
(To reset to 9 kHz interval, press the SHIFT key and MW 9 kHz key.)

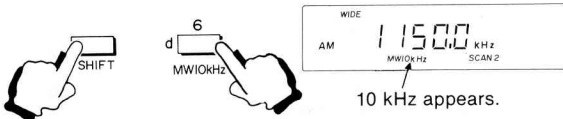

Once the frequencies of the stations are memorized, all you have to do is to push a key.

Up to 32 stations can be memorized to the a-1 to d-8 MEMORY PRESET keys. AM mode can also be memorized.

### HOW TO MEMORIZE A STATION

The numbers in the illustration refer to the sequence of operations.

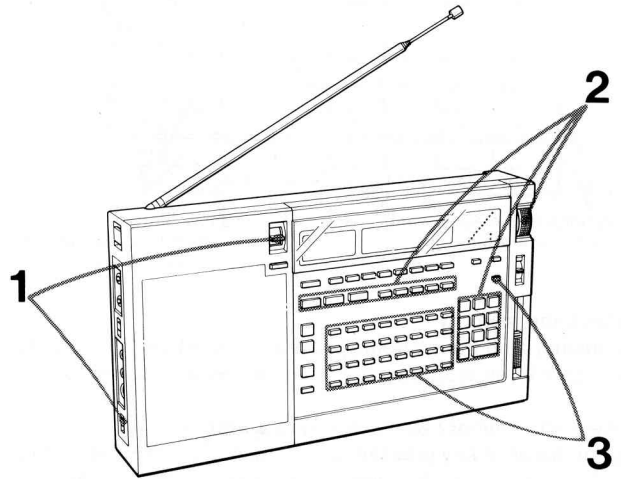

- 1 Set the MAIN POWER switch and the POWER switch to ON.
- 2 Tune in the desired station using any tuning method—direct tuning (page 10), manual tuning (page 11) or scan tuning (page 13), and set AM mode appropriately when receiving AM stations.
- 3 Keeping the ENTER key pressed, press one of the MEMORY PRESET keys.

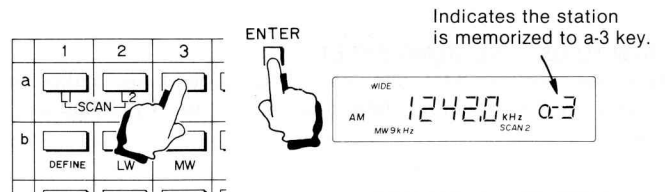

Repeat steps 2 and 3 for each MEMORY PRESET key.

- If you memorize another station to a key to which you have already memorized a station, the previous station will be erased. You cannot erase a station without memorizing another station.
- AM 150 kHz are memorized to all the keys at the factory.

#### Note

After replacing the computer/clock batteries, be sure to memorize the stations again. The memory contents will be erased when the batteries are removed.



# MEMORY SCAN TUNING

The stations memorized to the MEMORY PRESET keys are scanned from the a-1 key to d-8 key in sequence and scanning stops automatically for 5 seconds or so when a signal is received. Only the desired stations can be scanned by skipping the other memorized stations.

The numbers in the illustration refer to the sequence of operations.

## Example of memorizing stations

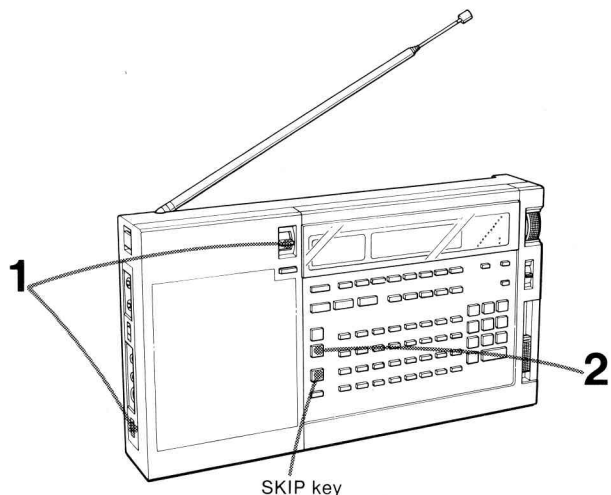
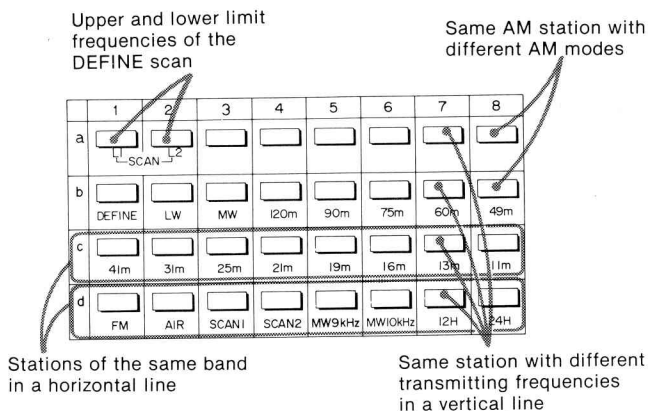

- 1 Set the MAIN POWER switch and the POWER switch to ON.
- 2 Press the MEMORY SCAN START/STOP key.  
The stations memorized to the a-1 key to the d-8 key will be scanned in sequence.

## To check the memory

After memorizing the stations, press each MEMORY PRESET key in turn to check the stations have been memorized correctly.

## To check the memory while receiving a station

Keeping the SKIP key pressed, press the MEMORY PRESET keys in turn. The memorized frequencies appear on the display in turn, while the station remains received. By releasing the keys, the frequency being received will be displayed. This is convenient for deciding the MEMORY PRESET key to which the just received station is to be memorized.

## HOW TO RECEIVE A MEMORIZED STATION

Turn on the receiver and press the MEMORY PRESET key. The memorized frequency will be received.

## HOW TO USE THE MEMO SHEET

Note the memorized frequencies on the supplied memo sheet and stick it to the information plate. You can refer to it by sliding out the plate.

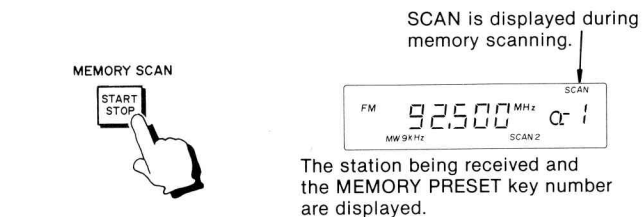
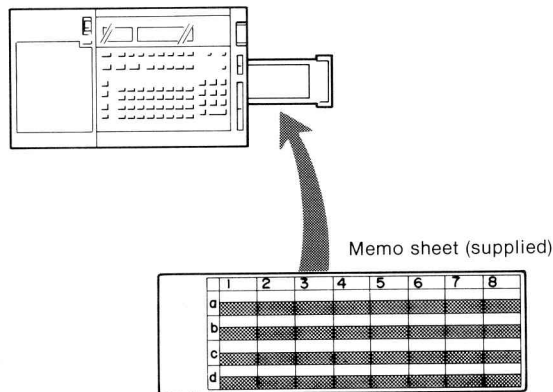

When a signal is received, scanning will stop for 5 seconds and will then resume.

To stop scanning, press the MEMORY SCAN START/STOP key.

## TO SCAN STATIONS OF SOME KEYS OR OF A CERTAIN BAND ONLY

### Skip mark

When a MEMORY PRESET key is pressed initially, the ▽ (skip) mark is displayed with the number of the key. This mark means that the key is skipped during memory scanning.

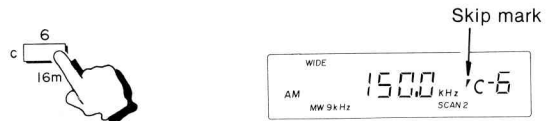

The skip mark initially appears with all the MEMORY PRESET keys. It will be erased automatically once a station is memorized to the key, so that the station can be located by memory scanning.

### To scan stations of some keys only

- 1 Press the MEMORY PRESET key to which the station you want to skip is memorized.
- 2 **Keeping the SKIP key pressed**, press the same MEMORY PRESET key again so the ▼ mark appears.

### To scan stations of a certain band (FM, AM or AIR\*) only

Example: To scan FM stations only

**Keeping the SKIP key pressed**, press the AM band select key (and the AIR band select key for certain models) once or twice so that the ▼ mark appears on the upper left of the band indication.

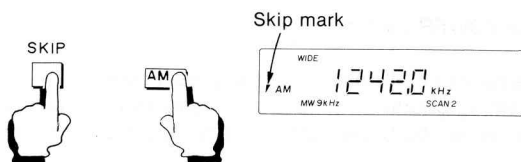

\* The AIR band is not provided with certain models.

### To check the keys to be skipped while receiving a station

**Keeping the SKIP pressed**, press the MEMORY PRESET keys from the a-1 key to the d-8 key in turn and check the ▼ mark. By releasing the keys, the previous station is received.

### To erase the ▼ mark

- 1 Press the MEMORY PRESET key for which you want to erase the ▼ mark.
- 2 **Keeping the SKIP key pressed**, press the same MEMORY PRESET key again. The ▼ mark will be erased.

### Notes

- The ▼ mark with the band indication has priority over that of a MEMORY PRESET key. So, when the ▼ mark is set with the band indication, the key is skipped even if the ▼ mark of the key itself has been erased.
- The SHIFT key and SKIP key do not function during memory scanning.

### Error indication

When all the MEMORY PRESET keys or all the bands (FM, AM and AIR) are skipped during memory scanning, this indication will appear for approx. 5 seconds and will then disappear. → Erase the ▼ mark of the required keys. See "To erase the ▼ mark".

## SLEEP TIMER OPERATION

—To turn off the receiver automatically

The receiver can be turned off automatically after 15, 30 or 60 minutes by the sleep timer.

- 1 Set the MAIN POWER switch to ON.
- 2 Set the POWER switch to OFF (or TIMER).
- 3 Select the sleep timer operation time by pressing the SLEEP key. With each push of the key, the digits of the operation time changes from 60 to 30 to 15 (minutes), then the receiver is turned off. With another push, 60 will appear again.

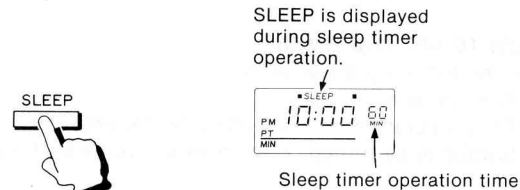

- 4 Tune in the desired station.

The remaining operation time is displayed as the time elapses. The receiver will be turned off automatically after the preset time.

### To turn off the receiver before the preset time

Press the SLEEP key repeatedly so that no digits of the operation time are displayed. Or, set the POWER switch ON, and then reset to OFF.

### To cancel the sleep timer and continue listening

Set the POWER switch to ON.

### Error indication

If you press the SLEEP key when there is no radio power source, this indication will appear for approx. 5 seconds and will then disappear. → Check the following.

- The MAIN POWER switch is set to OFF.
- The radio batteries are exhausted.
- The ac power adaptor or the car battery cord is connected to the DC IN 4.5 V jack when battery operation is attempted.
- The ac power adaptor or the car battery cord is not connected correctly to a wall outlet or a cigarette lighter socket of a car. When the power is supplied, the receiver is turned on and will be turned off automatically after the displayed time has elapsed.

# PROGRAMMABLE TIMER OPERATION

—To turn on the receiver automatically

Any memorized station can be turned on automatically at the desired time and turned off after 60, 30 or 15 minutes by the programmable timer. Four timer programs can be set.

## Before setting the timer

- Set the MAIN POWER switch and the POWER switch to ON.
- Memorize the stations to be turned on to the MEMORY PRESET keys.
- Adjust the VOLUME control to normal listening level.

## HOW TO SET THE TIMER

Set the following three items.

- ① Turn-on time
- ② Timer operation time (60, 30 or 15 minutes)
- ③ Station to be turned on (number of the MEMORY PRESET key)

**Example:** To receive the station memorized to the a-3 key for 30 minutes from 6:00 a.m.

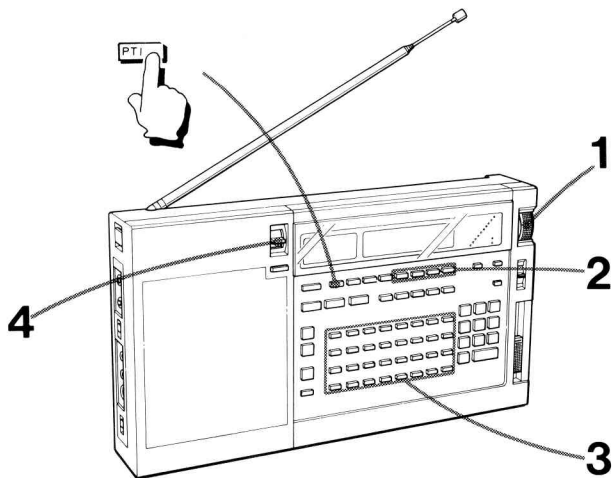

**1 Keeping the PT1 key pressed**, turn the TIME ADJ knob to set the turn-on time.

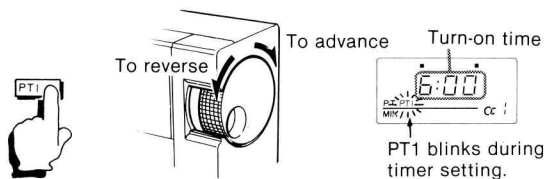

For 12 hour display, check the AM/PM indication.  
AM 12:00 = midnight, PM 12:00 = noon

**2 Keeping the PT1 key pressed**, press one of the OPERATION TIME keys (60, 30 or 15 minutes) to select the timer operation time.

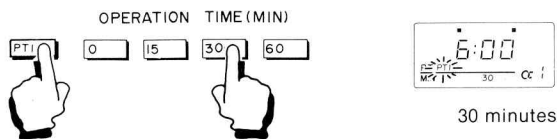

**3 Keeping the PT1 key pressed**, press the MEMORY PRESET key to which the station you want to receive is memorized.



Repeat the same procedure for setting other programs on PT2, PT3 and PT4 keys.

**4 Set the POWER switch to TIMER.**

The receiver will be turned on at the preset time. The remaining operation time is displayed as the time elapses. The receiver will be turned off automatically after the preset time.

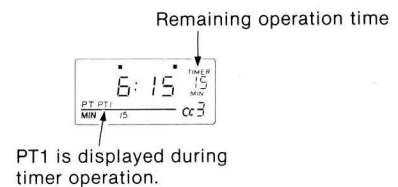

## To turn off the receiver before the preset time

Set the POWER switch to OFF. Reset it to TIMER to turn on the receiver at the next preset time.

## To check the timer programs

When the POWER switch is set to ON, press the PROGRAMMABLE TIMER key. When the POWER switch is set to TIMER or OFF, press the SLEEP key, and then the PROGRAMMABLE TIMER key. The preset timer program is displayed while the PROGRAMMABLE TIMER key is kept pressed.

## Note

During timer operation, the other timer programs cannot be checked.

The previous program will be cancelled when a new program is set on the same PROGRAMMABLE TIMER key.

## To cancel the timer program without a new input

Set the operation time to 0 by pressing the PROGRAMMABLE TIMER key and the OPERATION TIME 0 key.

## How to use the OPERATION TIME 0 key

When you do not want to turn on the receiver on a particular day only, set the operation time to 0 by pressing the PROGRAMMABLE TIMER key and the OPERATION TIME 0 key. The receiver will not be turned on at the preset time. Later, reset the operation time appropriately to turn on the next day.

## Examples of four timer programs

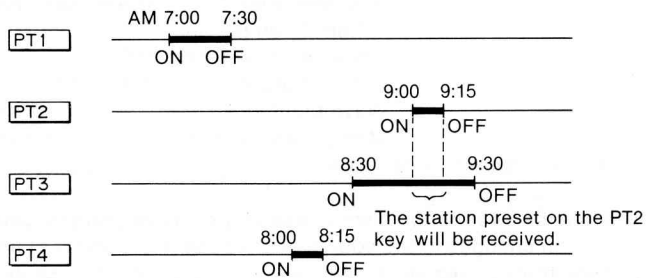

- The stations will be received in the order of the preset turn-on times. (PT1 → PT4 → PT3 → PT2 in the above example.)
- When two programs overlap, priority is given in the order from PT1 key to PT4 key. In the above example, the station preset on the PT2 key will be received from 9:00 to 9:15 and the station preset on PT3 key will return from 9:15 to 9:30.

### To use the sleep timer after setting the timer programs

Press the SLEEP key and tune in the desired station. You can fall asleep listening to the radio and woken up by the other program.

- The programmable timer has priority over the sleep timer. So, if the turn-on time of the programmable timer comes during the sleep timer operation, the station preset on the PT key will be received.

### Error indication

Error

During programmable timer operation, none of the keys on the front panel except the LIGHT key and the BATTERY CHECK key nor the MANUAL TUNING/TIME ADJ knob function. When you touch a key or the knob, this indication will appear for approx. 5 seconds and will then disappear. ➔ To operate the keys or the knob, set the POWER switch to ON.

## EXTERNAL ANTENNA CONNECTION

(Only for models with the external antenna jacks provided)

### FOR FM/AIR BAND RECEPTION

In a steel-frame building, a mountainous area, at a distance from the transmitter or in a location where ignition noise is severe, FM/AIR band reception may be unsatisfactory with the telescopic antenna. In this case, connect the optional Sony AN-3 VHF antenna or other appropriate external antenna.

#### Connection

See illustration [H] on page 4.

- 1 Connect the 50–75 ohm coaxial cable to the supplied antenna connector.
  - ① Fold the tabs on the antenna connector.
  - ② Prepare the end of the cable as illustrated.
  - ③ Fix the center conductor and shield braid as illustrated.
  - ④ Close the lid and tighten the screws.
- 2 Connect the antenna connector to the EXT ANT AIR/FM jack of the receiver.

#### Notes

- Locate an outdoor antenna as far away from the street as possible.
- For further details, refer to the antenna instruction manual.

### FOR SW RECEPTION

Usually, the telescopic antenna is sufficient for SW reception. However, in a building or for more stable SW reception, the use of the supplied SW external antenna is recommended.

#### Connection

See illustration [I] on page 4.

- 1 Connect the ground wire (if necessary) and the spade lug of the SW external antenna to the terminals on the supplied antenna connector, close the lid and tighten the screws.
- 2 Connect the antenna connector to the EXT ANT AM jack of the receiver.

When reception is noisy, connect one end of a ground wire to the antenna connector as illustrated and the other end directly to a convenient earth ground.

#### Notes

- When an external antenna is connected to the EXT ANT AM jack, the built-in ferrite bar antenna does not function.
- Never connect a ground wire to a gas pipe. Doing so could cause a fire.
- When there is lightning and you are using an external antenna, immediately disconnect the ac power adaptor (if connected) from the wall outlet. Never touch the antenna wire during a lightning storm.

### FOR MW/LW RECEPTION

Use an optional AN-1 wide range antenna for better reception.



#### Connection

See illustration [J] on page 4.

Connect the OUTPUT of the antenna controller\* and the INPUT of the antenna coupler\* with the RK-69A connecting cord\* or connect the OUTPUT of the antenna controller and the EXT ANT of the ICF-2001D with the connecting cord.

\* supplied with the AN-1 wide range antenna.

# RECORDING A BROADCAST

See illustration  on page 4.  
Connect a tape recorder to the  jack of the receiver.  
Tune in the desired station and set the recorder to record mode.  
The volume control setting on the receiver has no effect on the recording.

## SPECIFICATIONS

Circuit system	FM: Superheterodyne AIR/AM: Dual conversion superheterodyne
Frequency range	AIR: 116–136 MHz* FM Type 1: 76–108 MHz Type 2: 87.5–108 MHz AM Type 1: 150–29999.9 kHz Type 2: 150–26100 kHz Type 3: 150–285 kHz, 530–26100 kHz (For the frequency range of your receiver, see the front panel of the receiver.)
Antennas	AIR/FM/SW: Telescopic antenna MW/LW: Built-in ferrite bar antenna External antenna terminal for AIR/FM* External antenna terminal for AM (LW/MW/SW)*
Speaker	Approx. 10 cm (4 inches) diameter
Power output	380 mW (at 10% harmonic distortion)
Outputs	Recording output jack (minijack) Output level 0.775 mV (–60 dB) Output impedance 1 kilohm Earphone jack (minijack)
Power requirements	Radio: 4.5 V dc Three IEC designation R20 batteries (size D) DC IN 4.5 V jack accepts: • Supplied ac power adaptor* for use on 110, 120, 220 or 240 V ac, 50/60 Hz • Optional DCC-127A car battery cord for use with 12 V car battery Computer/clock: 3 V dc, two IEC designation R6 batteries (size AA)
Battery life	Radio: Approx. 45 hours (FM reception) Approx. 32 hours (AM/AIR reception) using Sony SUM-1(NS) New Super batteries Computer/clock: Approx. 1 year using Sony SUM-3 (NS) New Super batteries The battery life assumes listening to the radio for four hours a day at normal volume.
Dimensions	Approx. 288 × 159 × 52 mm (w/h/d) (11 <sup>3</sup> / <sub>8</sub> × 6 <sup>3</sup> / <sub>8</sub> × 2 <sup>1</sup> / <sub>8</sub> inches) incl. projecting parts and controls with antenna retracted
Weight	Approx. 1.7 kg (3 lb 12 oz) incl. batteries

Accessories supplied	AC power adaptor (1)* Earphone (1) Shoulder strap (1) (To attach, see illustration  on page 4.) SW external antenna (1)* External antenna connector (2)* Wave handbook (1) Memo sheet and information sheet (1 set)
----------------------	--

\* Not provided with certain models

While the information given is true at the time of printing, small production changes in the course of our company's policy of improvement through research, and design might not necessarily be indicated in the specifications. We would ask you to check with your appointed Sony dealer if clarification on any point is required.

### OPTIONAL ACCESSORIES

Car battery cord	DCC-127A
Connecting cord	RK-69A
VHF antenna	AN-3
LW/MW/SW wide range antenna	AN-1

## TROUBLESHOOTING GUIDE

Should any problem occur with the set, make the following simple tests to determine whether or not servicing is required.

If the problem persists after you have made these tests, consult the nearest Sony dealer for further information.

### GENERAL

#### No clock/timer display

- Incorrect polarity of computer/clock batteries. See page 8.
- Weak computer/clock batteries.

#### Display is dim.

- Weak computer/clock batteries.
- The set is being used in extremely high temperatures or in a place with excessive moisture.

#### Sound is not heard at all.

- Weak radio batteries.
- Incorrect polarity of radio batteries. See page 9.
- The VOLUME control is slid down completely.
- The earphone is plugged in.

#### Very weak or interrupted sound, or unsatisfactory reception.

- Weak radio batteries.
- Tuning or antenna adjustment is not correct.  
➔ Tune in precisely with the MANUAL TUNING knob. For antenna adjustment, see page 12.
- Weak signal.  
➔ In a vehicle or in a building, listen near a window.  
➔ For AM reception, set the AM RF GAIN control to MAX and the AM ATT selector to DX.

### TUNING

#### A frequency cannot be input in direct tuning.

- The next key was not pressed within 5 seconds after a key has been pressed.

#### Scanning does not stop.

- In SCAN 2 mode, scanning resumes after a station is received for 1.5 seconds. ➔ Set to SCAN 1 mode. See page 14.
- Weak signal.  
➔ Adjust the antenna.  
➔ For AM reception, set the AM RF GAIN control to MAX and the AM ATT selector to DX.

#### Scanning does not begin.

- A strong station is being received. ➔ Press the SCAN START/STOP key repeatedly until scanning begins.
- There are many strong stations.  
➔ For AM reception, gradually slide the AM RF GAIN control toward MIN. If it is set to MAX, set the AM ATT selector to LOCAL.

#### The desired band or frequency range cannot be scanned with push of the SCAN key

- The broadcast band or the frequency range which you want to scan has been memorized incorrectly. See pages 13 to 15.

#### A frequency cannot be memorized.

- Incorrect memorizing procedure. ➔ Keeping the ENTER key pressed, press one of the MEMORY PRESET keys.

#### The memorized frequency cannot be tuned in even if the MEMORY PRESET key is pressed.

- The memory has been erased. ➔ After replacing the computer/clock batteries, be sure to memorize the stations again.

#### A required station cannot be received during memory scanning.

- The station is skipped as the ▽ mark is displayed with the MEMORY PRESET key indication or the band indication.  
➔ Erase the ▽ mark. See page 17.
- The station is weak.  
➔ Adjust the antenna.
- ➔ For an AM station, set the AM RF GAIN control to MAX and the AM ATT selector to DX.

### PROGRAMMABLE TIMER

#### The receiver does not turn on at the preset time.

- The POWER switch is not set to TIMER.
- The memory of the timer setting has been erased. ➔ After replacing the computer/clock batteries, be sure to reset it.
- The MAIN POWER switch is set to OFF.
- The timer operation time is set to 0.

### ERROR INDICATIONS

 (Appears during direct tuning.)

- A frequency beyond the receivable range has been input.
- The band of the input frequency (AIR, FM or AM) is selected incorrectly.

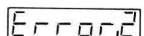
 (Appears during programmable timer operation.)

- The programmable timer is operating and the key or the control you have touched cannot be activated.

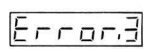
 (Appears when the POWER switch is set to ON or when the SLEEP key is pressed.)

- The MAIN POWER switch is set to OFF.
- Weak radio batteries.
- Incorrect polarity of radio batteries.
- The ac power adaptor or the car battery cord is not connected securely.
- Battery operation is attempted while an ac power adaptor or a car battery cord is connected to the DC IN 4.5 V jack, but not to a wall outlet or a cigarette lighter socket.

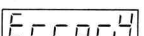
 (Appears during memory scanning.)

- All the memorized stations are skipped. ➔ Erase the ▽ mark. See page 17.